



Supplement of

EKONT-2: advancement of a demonstrator for dry–mechanical decontamination of corners and inner edges in nuclear facilities

Eric Rentschler et al.

Correspondence to: Eric Rentschler (eric.rentschler@kit.edu)

The copyright of individual parts of the supplement might differ from the article licence.

EKONT-2: Advancement of a demonstrator for dry-mechanical decontamination of corners and inner edge in nuclear facilities

Eric Rentschler, Sascha Gentes, Martin Villinger, Kurt Heppler, Stefan Stemmler, Johannes Greb

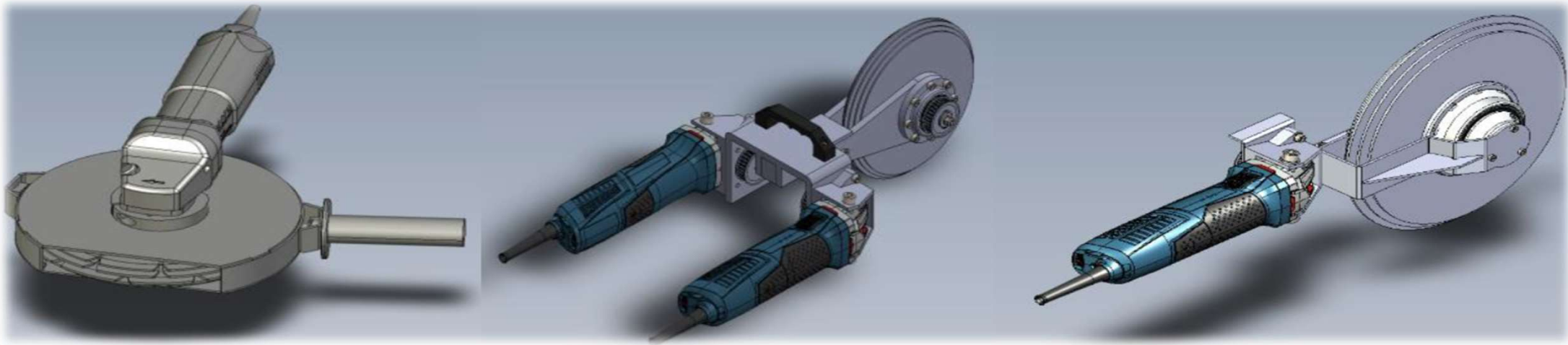

Contents

- Project partners
- Basics about EKont
- Currently used tools
- Developed Cutting technologies
- Test bench and research investigations
- Conclusion and Outlook

SPONSORED BY THE



Federal Ministry
of Education
and Research



Project Partners



- Partner for research, design of the test bench and experiment series



- Industry partner, expert in concrete surface work and diamond cutting



- Partner for research in mechanical engineering and design of demonstrators



- Industry partner, expert in nuclear dismantling, decommissioning and decontamination

Basics about EKont

- Development of an innovative, semi-automated demonstrator for dry-mechanical decontamination of corners, edges and impurities for nuclear facilities (01.08.2019 – 30.06.2023)
- Comparison of the performance parameters
- Development and construction of new demonstrators
- **Follow-up research project: EKONT-2 (01.07.2023–30.06.2026), Advancement of a demonstrator for dry-mechanical decontamination of corners and inner edge in nuclear facilities**



Currently used tools



needle gun DIMU type 34 B [1]



Currently used tools A:
B: milling tool enviro C25 [2]



C: concrete grinder enviro ASM 125 [3]

Source: [1] Dieter Muthmann GmbH; <https://www.dimu.de/nadelpistole-typ-34-b.html>. [Accessed 08 06 2021].
[2] ASUP GmbH; <https://asup.info/marken/enviro/enviro-eckfraese-c25>. [Accessed 08 06 2021].
[3] ASUP GmbH; <https://asup.info/marken/enviro/enviro-hand-schleifmaschine-asm-125>. [Accessed 08 06 2021].

Developed Cutting technologies

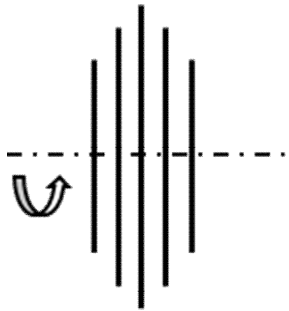

a) Step cutter with co-rotating direction

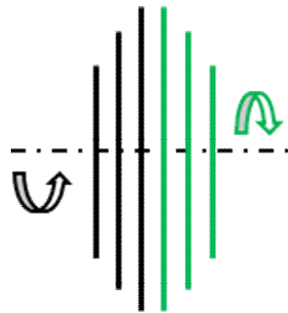

b) Step cutter with contrary direction of rotation

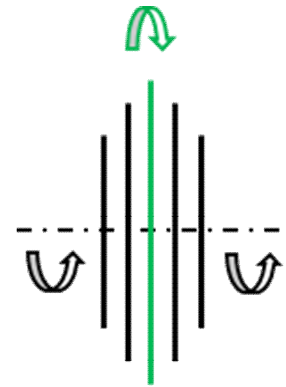

c) Step cutter with concentric contrary direction of rotation

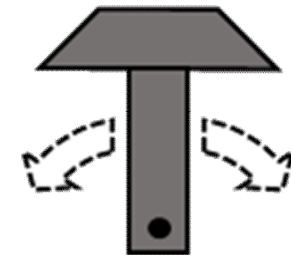

d) Oscillating toolhead

New developed prototypes

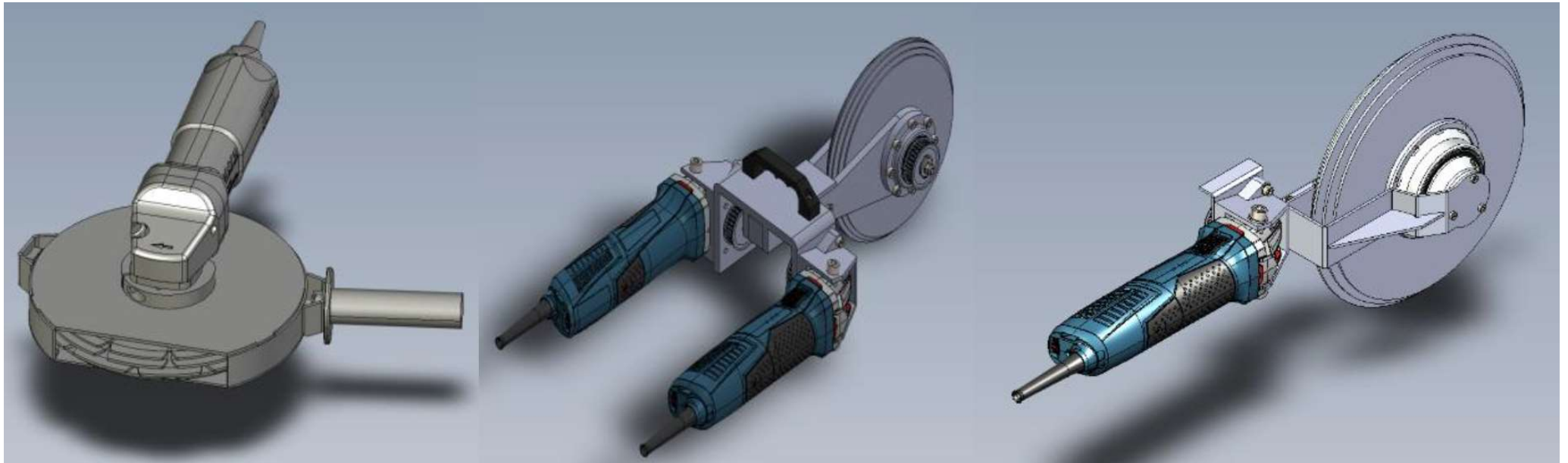

Technical design of the test bench

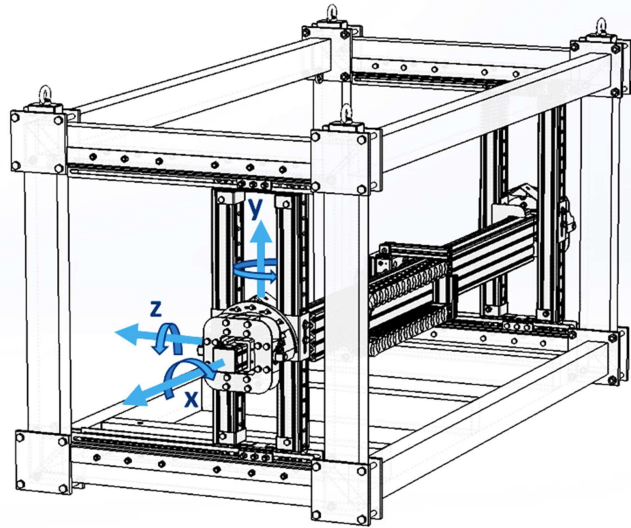

Technical design of the test bench



Tool holder with prototype A (left) and prototype B (right)

Scientific Investigations and experimentally collected performance parameters

■ Internal factors

- Feed rate (*Linear unit*)
- Removal depth per operation (*Kardan joints*)
- Direction of rotation
- Direction of operation

■ External factors

- Forces and torques (*6-axis sensor*)
- Surface roughness (*Laser scanner*)
- Vibrations (*Vibration meter*)
- Sound level (*sound level meter*)
- Demonstrator weight
- Amount of dust (*real-time dust monitor*)
- Particulate matter (*grainsize measur*)

Test Series

Over 70 test and experiment series with average 6 tested parameters
 = more than 420 data series

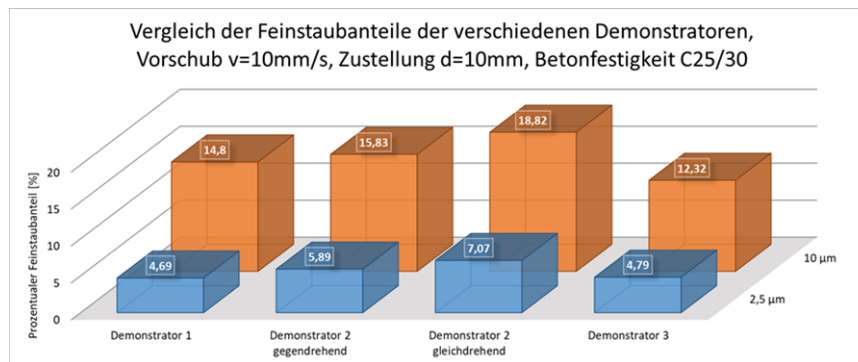
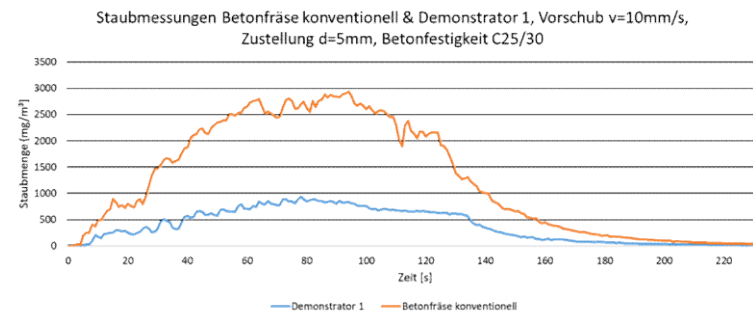
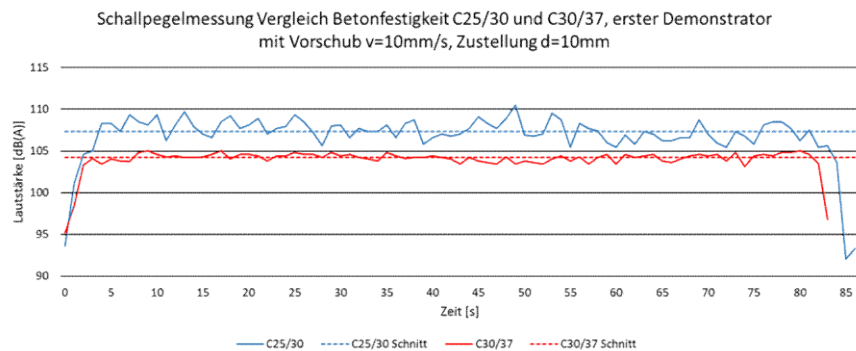
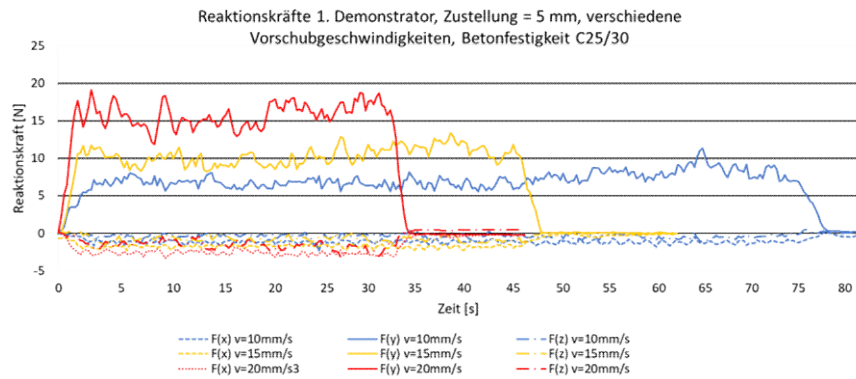

Step cutter with co-rotating direction

- Five diamond discs
- All discs co-rotating in one direction
- One engine

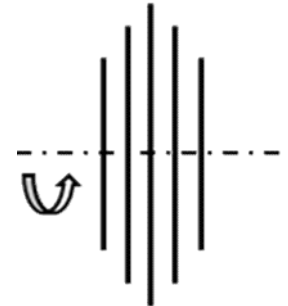

+	-
Forces	Vibrations
Amount of dust	Sound level
Demonstrator weight	
Particle matter	
Surface roughness	



Step cutter with contrary direction of rotation

- Six diamond discs
- Contrary direction of rotation
- Two engines

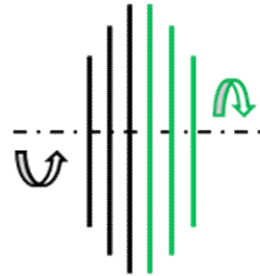

+	-
Sound level	Amount of dust
Vibrations	Demonstrator weight



Step cutter with concentric contrary direction of rotation

- Five diamond discs
- Concentric (middle) disc contrary direction of rotation
- One engine

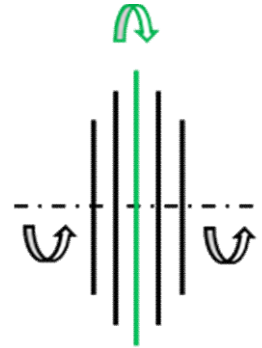

+	-
Amount of dust	Demonstrator weight
Particle matter	Surface roughness
	Sound level



Oscillating toolhead

- Diamond head for corners and inner edges
- Oscillating (vibrating) toolhead
- One engine

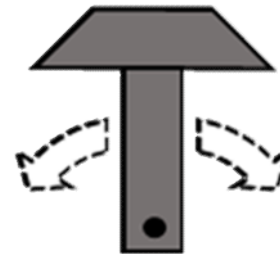

+	-
Demonstrator weight	Feed rate
Inner corners	Removal depth
	Vibrations



Laser scanning

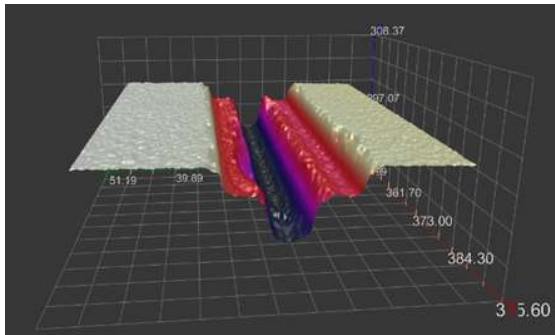

a) Step cutter with co-rotating direction

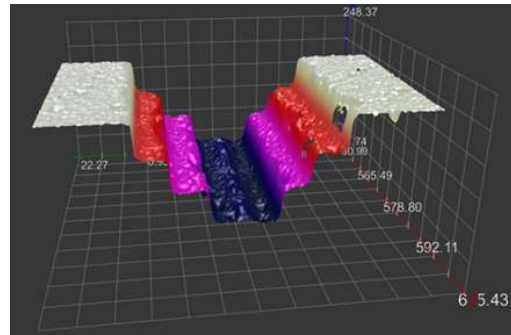

b) Step cutter with contrary direction of rotation

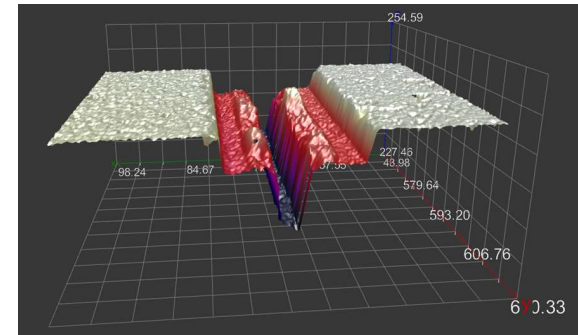

c) Step cutter with concentric contrary direction of rotation

Laser scanning

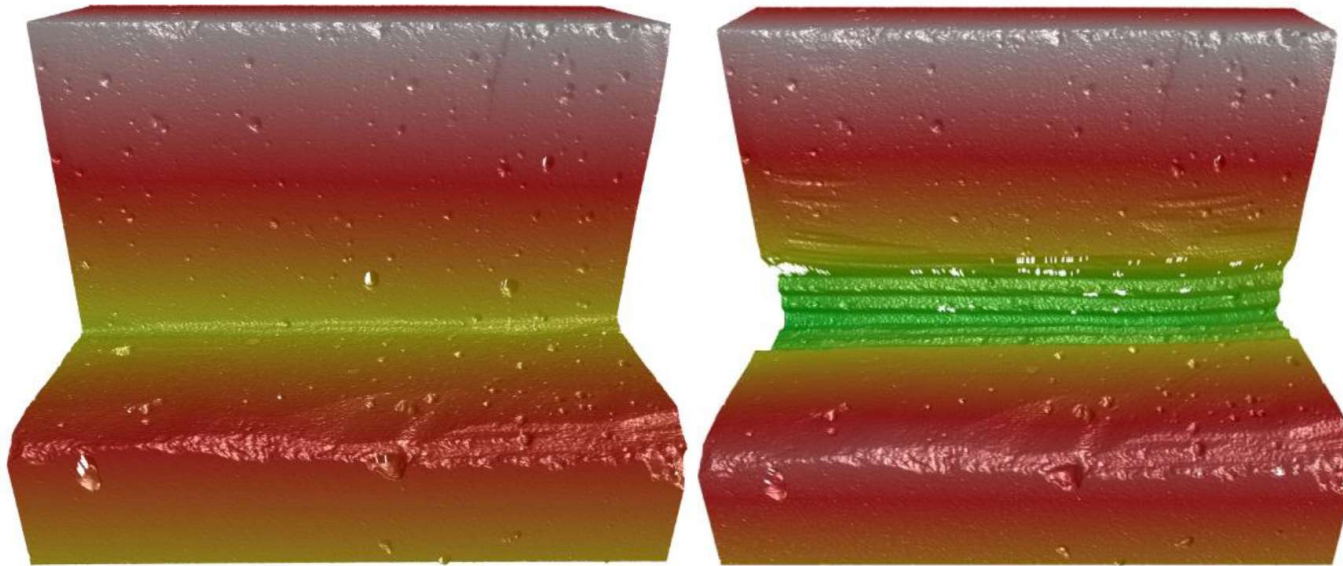

3D displays for the inner edge before (left) and after (right) the test with the prototype A

Practice tests at Nuclear Power Plant Obrigheim

		Ergonomics	Performance	Surface Roughness
Step Cutter	1	Good	Very good	Very good
	2	Demonstrator -weight too heavy		Good
	3			Leftover Concrete Bridges
Oscillating Tool	4	Good	Too low	Very good

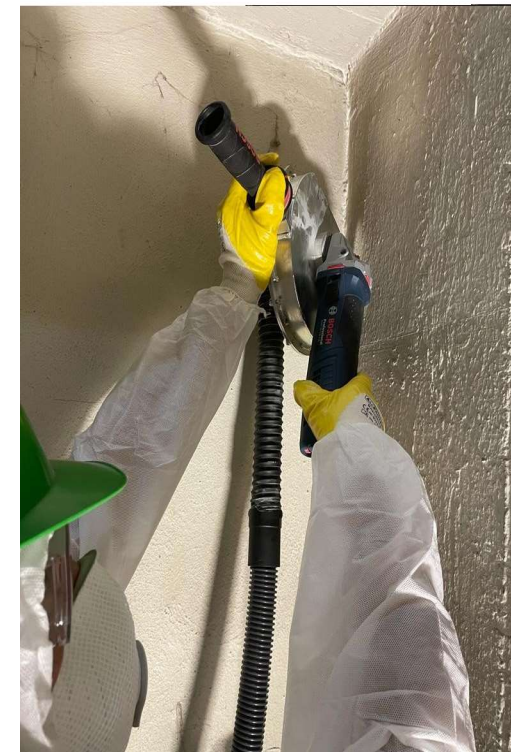

Conclusion EKont and Outlook EKONT-2

- **„Keep the good things and improve the bad things“**
 - The research project delivered four fully working demonstrators
 - The test bench showed, which demonstrator performs well in a specific field
 - Forces and torques, Sound level, Vibrations, Surface roughness, Dust, etc...
 - The tests on site of the NPP showed, which aspects are really important
 - E.g. Demonstrator weight for the Nuclear Site workers

- **Future planned improvements in the development:**
 - Tool weight
 - Dimensions of the tools
 - Surface quality especially for clearance measurement
 - Exact depth performance
 - Overall safety improvements for workers



H
T
W
G

Hochschule Konstanz
Technik, Wirtschaft und Gestaltung



Thank you for your attention

SPONSORED BY THE



Federal Ministry
of Education
and Research

Contact:
Eric Rentschler
+49 721 608 44121
Eric.rentschler@kit.edu